

Nákupní taška

1 cm

Kontrolní čtvereček – při zvětšení stříhu si překontrolujte, zda tento čtvereček měří 1×1 cm.

Střihový plán

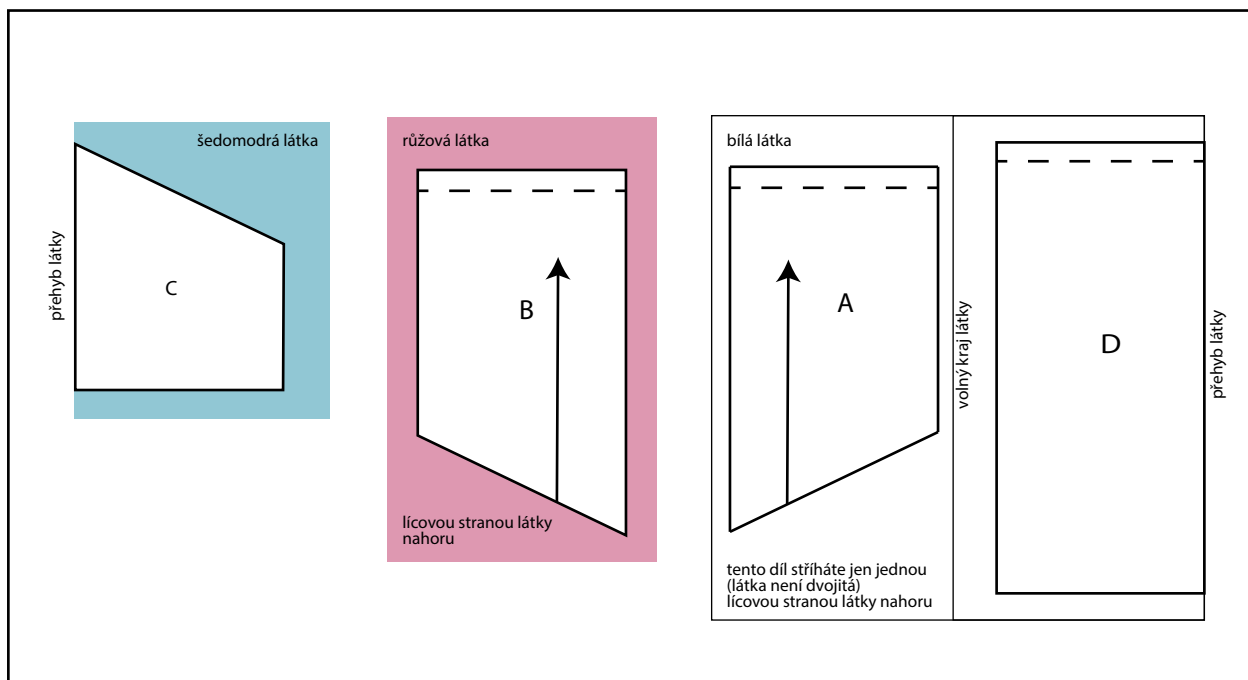

A1

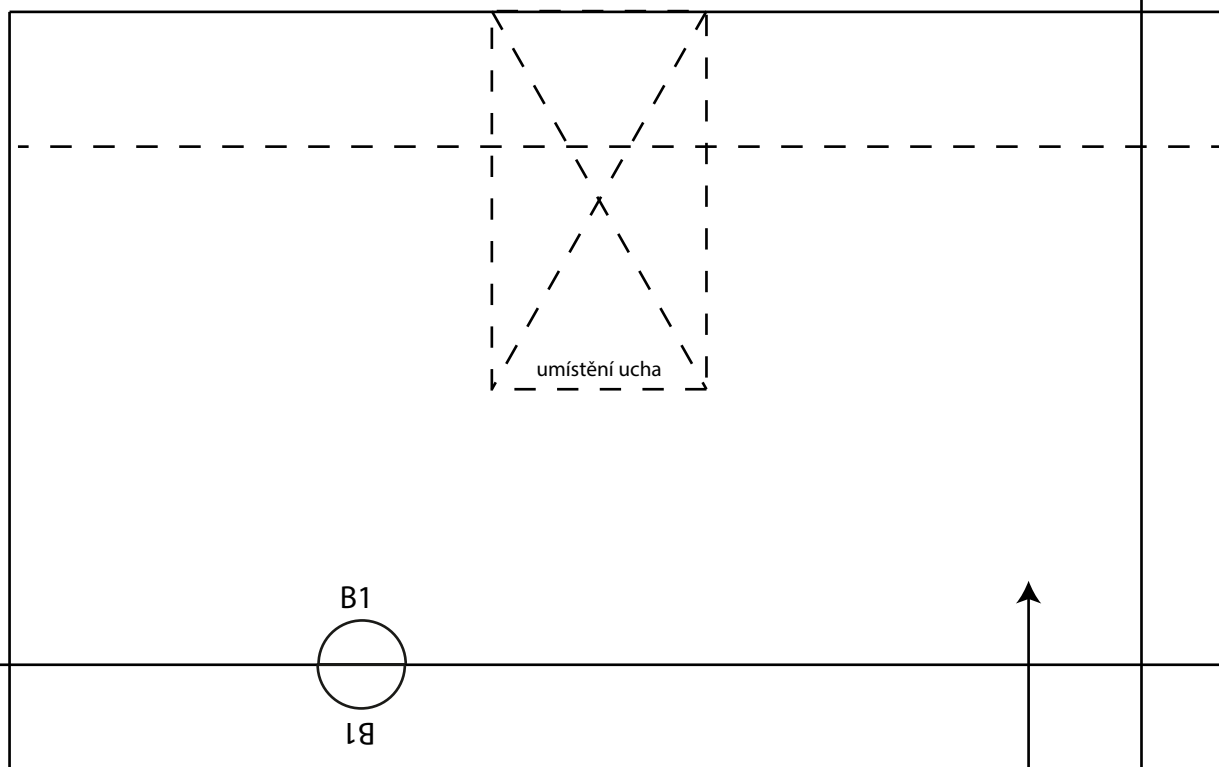

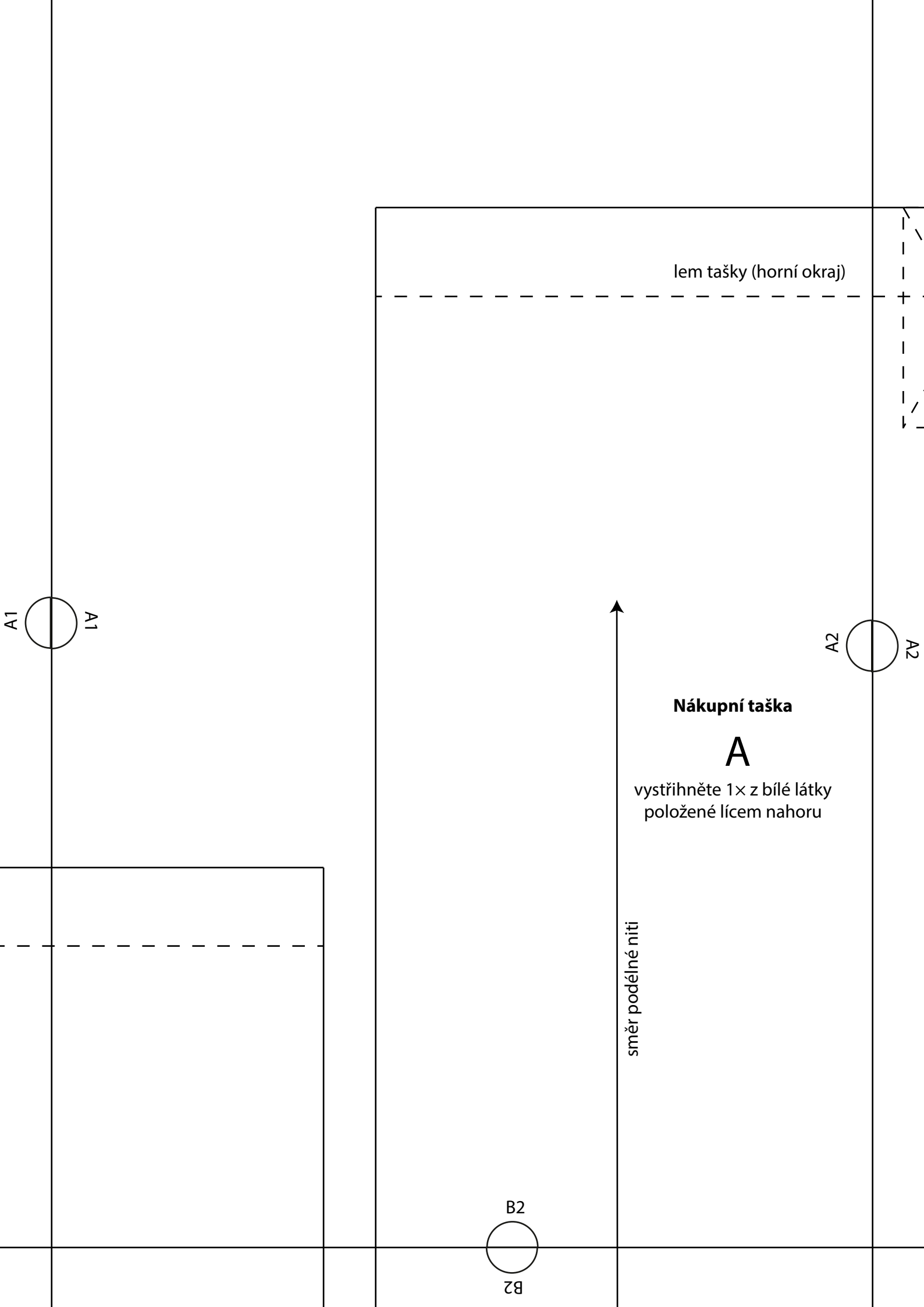

lem tašky (horní okraj)

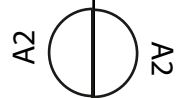
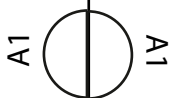

Nákupní taška

A

vystřihněte 1× z bílé látky
položené lícem nahoru

směr podélné niti

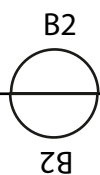

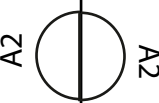

A2

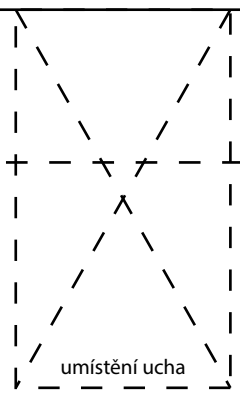

umístění ucha

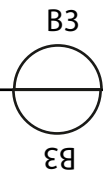

B3

B3

šev (díly A/B)

přehyb látky | směr podélné niti

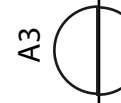

A3

A3

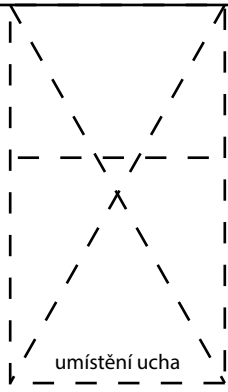

lem tašky (horní okraj)

umístění ucha

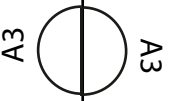

Nákupní taška

D

vystřihněte
1× z přeložené
bílé látky

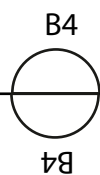

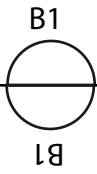

Nákupní taška

B

vystřihněte
1× z růžové látky
(lícová strana nahoru)

šev (díly A/B)



směr podélné niti

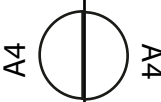

směr podélně niti

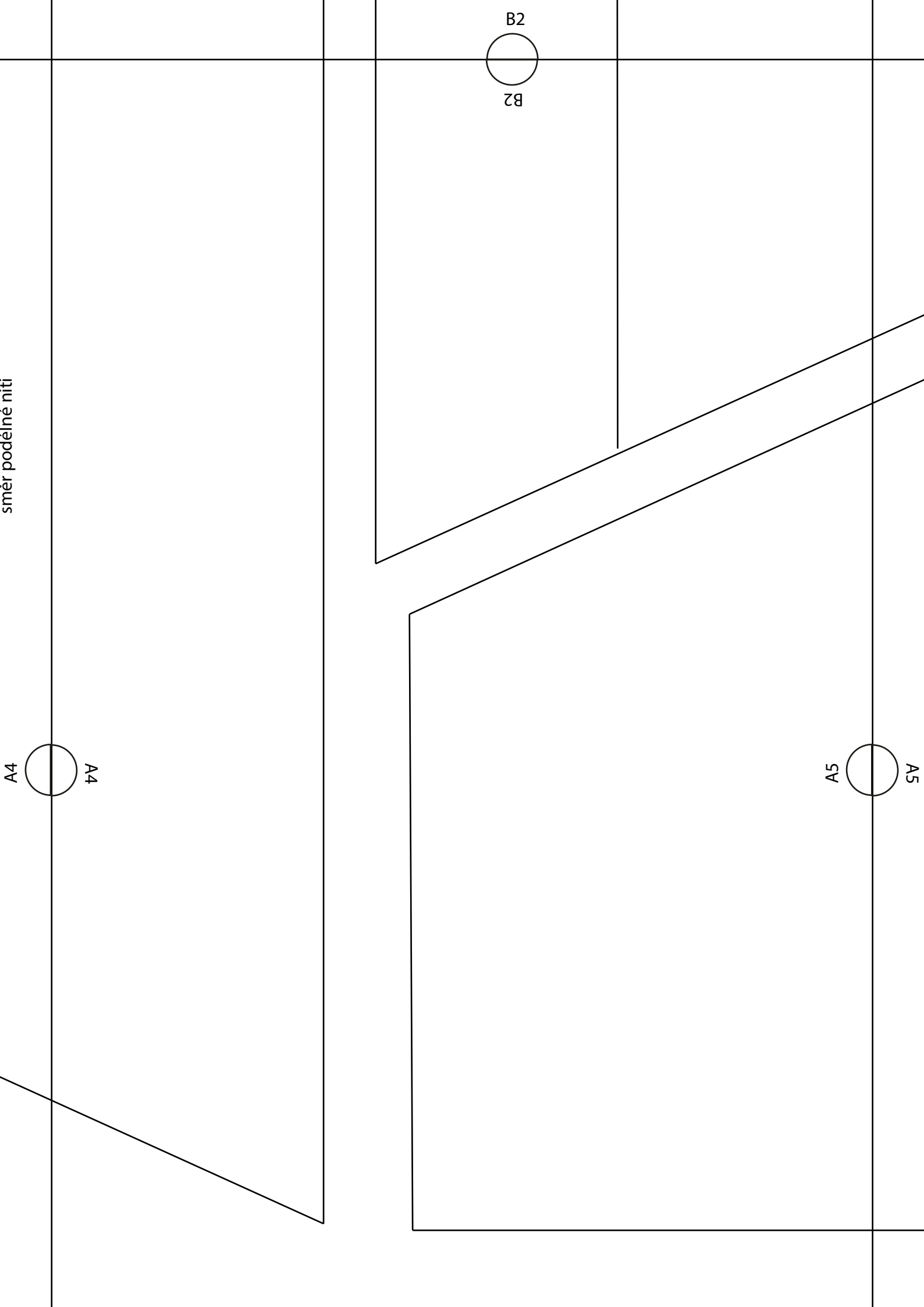
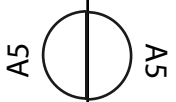
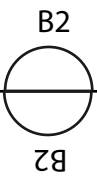
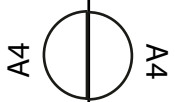

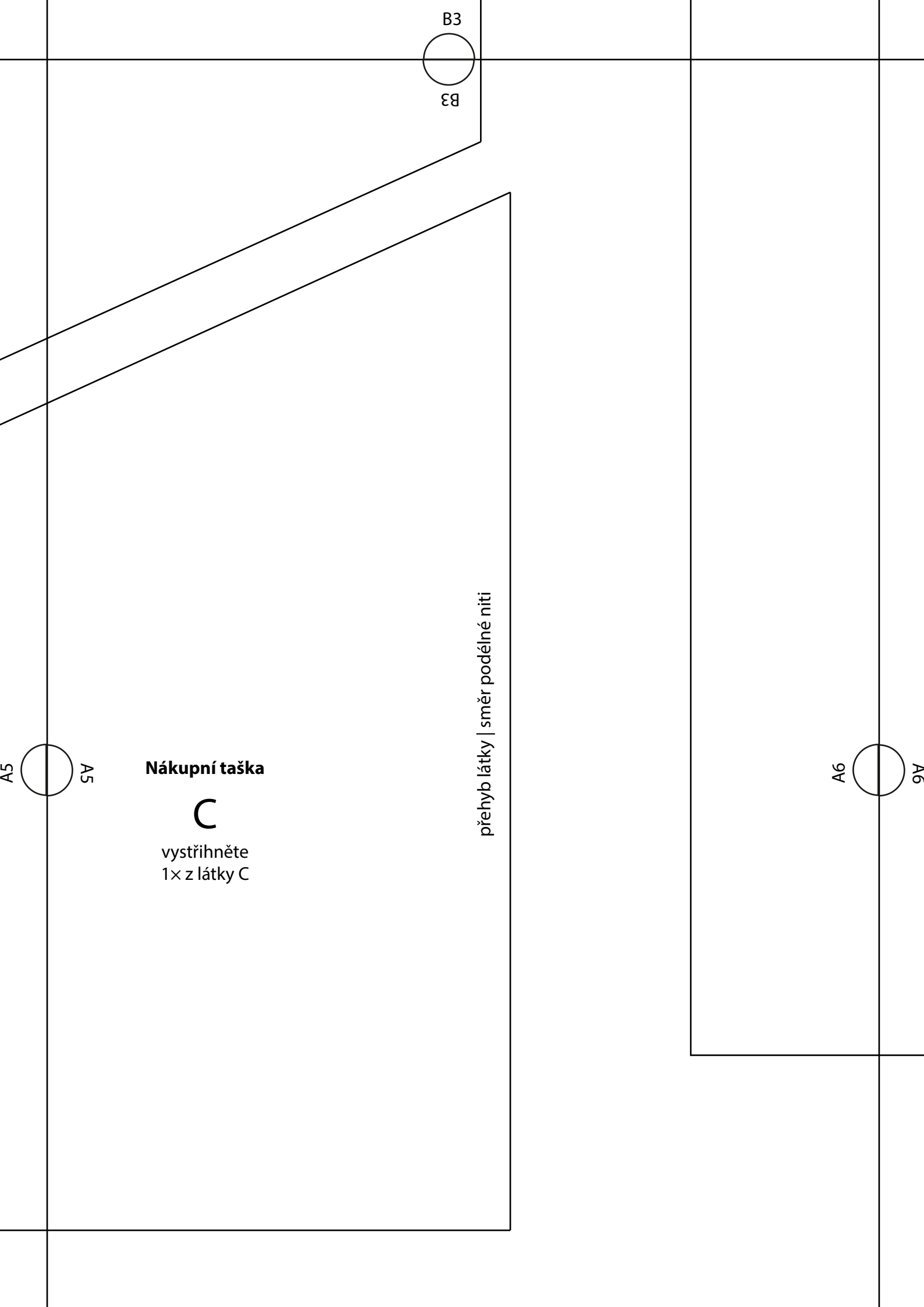

B3

B3

A5

A5

Nákupní taška

C

vystřihněte
1× z látky C

přehyb látky | směr podélné niti

A6

A6

B4



B4

A6



A6